



Ethene, Ethylene Gas Sensor C2H4/M-1500

C2H4 Gas Sensor in Miniature Housing

Applications

- Discontinuous Measurement
- Fruit Ripening
- For Portable Gas Detectors

Measurement

Operation Principle	3-Electrode Electrochemical
Nominal Range	0 - 1500 ppm
Maximum Overload	3000 ppm
Inboard Filter	-
Output Signal	11 ± 5 nA/ppm
Resolution (Electronics dependent)	< 4 ppm
T80 Response Time	< 60 s
Typical Baseline Range (pure air, 20°C)	-10 ppm to 35 ppm
Maximum Zero Shift (+20°C to +40°C)	73 ppm
Repeatability	< 2 % of signal
Output Linearity	Linear
Gain (Only applies to 4-Electrode sensors)	-

Performance data recorded at 20 – 25 °C, 30 - 50% RH, 900 - 1100 mbar

For further information about usage of Membrapor sensors, see application note [MEM1](#). The data contained in this document is for guidance only. Membrapor AG accepts no liability for any consequential losses, injury or damage resulting from the use of this document or from any omissions or errors herein. Customers should test under their own conditions to ensure that the sensors are suitable for their own requirements.



Ethene, Ethylene Gas Sensor C2H4/M-1500

Electrical

Rec. Load Resistor	10 - 33 Ω
Bias (V_Sens-V_Ref)	not recommended
Conformity to RoHS directive	RoHS Compliance

Environmental

Relative Humidity Range	15 % to 90 % RH non-condensing
Temperature Range	-40 °C to 50 °C
Pressure Range	Atmospheric \pm 10%
Pressure Coefficient	N.D.
Humidity Effect	None

Lifetime

Expected Operation Life	2 years in air
Expected Long Term Output Drift in air	< 5 % signal loss per month
Filter Life	
Storage Life	6 months in container
Rec. Storage Temperature	5°C - 20°C
Warranty Period	12 months from date of dispatch

Performance data recorded at 20 – 25 °C, 30 - 50% RH, 900 - 1100 mbar

For further information about usage of Membrapor sensors, see application note [MEM1](#). The data contained in this document is for guidance only. Membrapor AG accepts no liability for any consequential losses, injury or damage resulting from the use of this document or from any omissions or errors herein. Customers should test under their own conditions to ensure that the sensors are suitable for their own requirements.



Ethene, Ethylene Gas Sensor C2H4/M-1500

Miniature-Size Outline Dimensions

BOTTOM VIEW

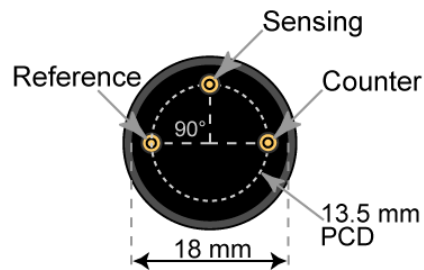

SIDE VIEW

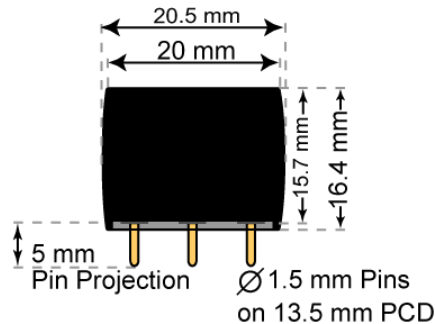

± 0.10 mm

Mechanical

Weight	5.5 g
Orientation	Any
Housing material	Polycarbonate

Performance data recorded at 20 – 25 °C, 30 - 50% RH, 900 - 1100 mbar

For further information about usage of Membrapor sensors, see application note [MEM1](#). The data contained in this document is for guidance only. Membrapor AG accepts no liability for any consequential losses, injury or damage resulting from the use of this document or from any omissions or errors herein. Customers should test under their own conditions to ensure that the sensors are suitable for their own requirements.



Ethene, Ethylene Gas Sensor C2H4/M-1500

Cross Sensitivity Data

The table below does not claim to be complete. Interfering gases should not be used for calibration. Please contact Membrapor AG for further support regarding cross sensitivities.

Interfering Gas	Cross-Sens. [%]
CO	< 60

Performance data recorded at 20 – 25 °C, 30 - 50% RH, 900 - 1100 mbar

For further information about usage of Membrapor sensors, see application note [MEM1](#). The data contained in this document is for guidance only. Membrapor AG accepts no liability for any consequential losses, injury or damage resulting from the use of this document or from any omissions or errors herein. Customers should test under their own conditions to ensure that the sensors are suitable for their own requirements.