

ME A-960-LTE

OMNI-DIRECTIONAL ANTENNA

Part #: 100-00140-01

Description

The MEA-960-LTE is a rugged antenna that provides broad coverage 690 - 960 MHz & 1710 - 2700 MHz. The antenna is compatible with most 4G LTE standards. This is a high efficiency, high gain, omni-directional antenna. The antenna is 82 mm long, featuring a tilt-and-swivel SMA plug connector.

Electrical Specifications

Parameter	Specification
Frequency Range	690-960 / 1710-2700 MHz
VSWR	1:3.5
Impedance	50 Ω
Polarization	RHCP
Gain	3 dBi \pm 1
Polarization	Vertical
Radiation	Omni-directional
Max Power	20 W

Mechanical Specifications

Parameter	Specification
Height	82 mm
Max Diameter	\varnothing 12 mm
Min Diameter	\varnothing 6 mm
Connector	SMA male
Lighting Protection	Grounding



Features

- 690 - 960 MHz / 1710 - 2700 MHz
- SMA Male Connector
- Efficient High Gain
- Tilt and Swivel Design
- Rugged

Applications

- Telemetry
- Gateways
- IOT/M2M Applications
- Smart Metering

Radiation Performance

690 - 960 MHz

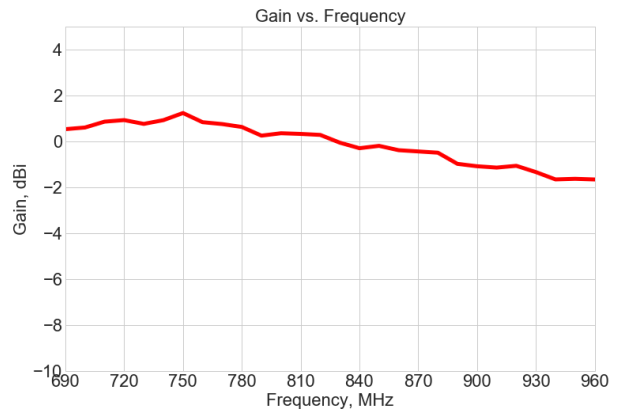
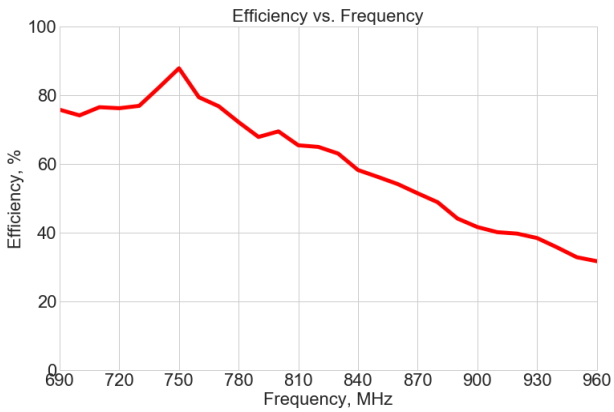
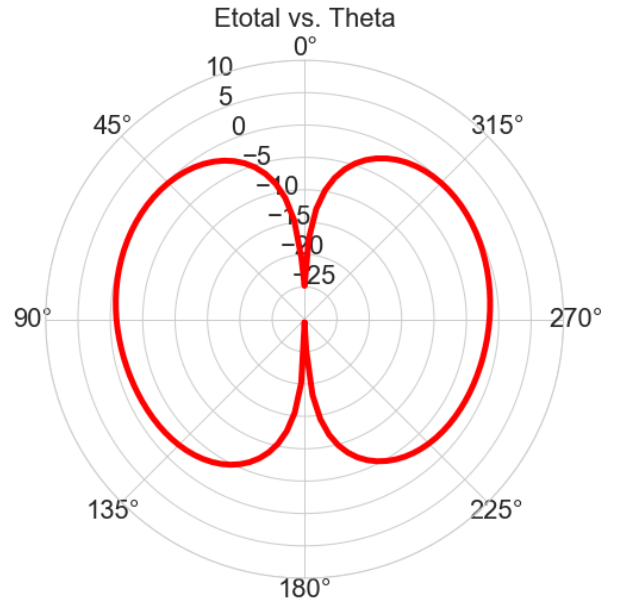
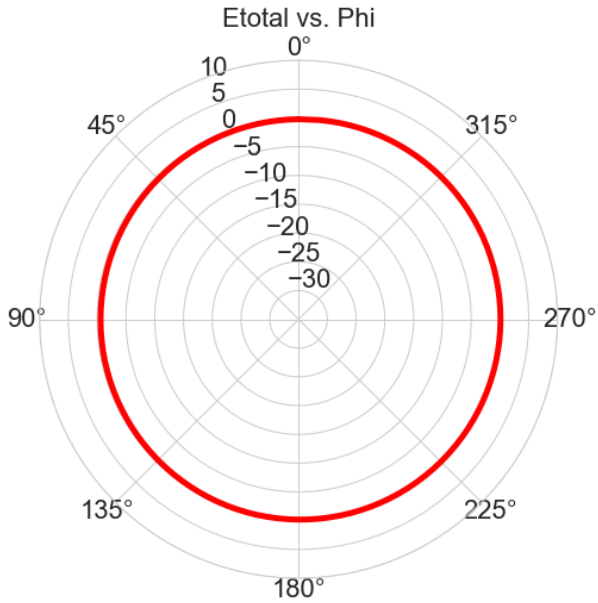

Radiation Performance

1710 - 2700 MHz

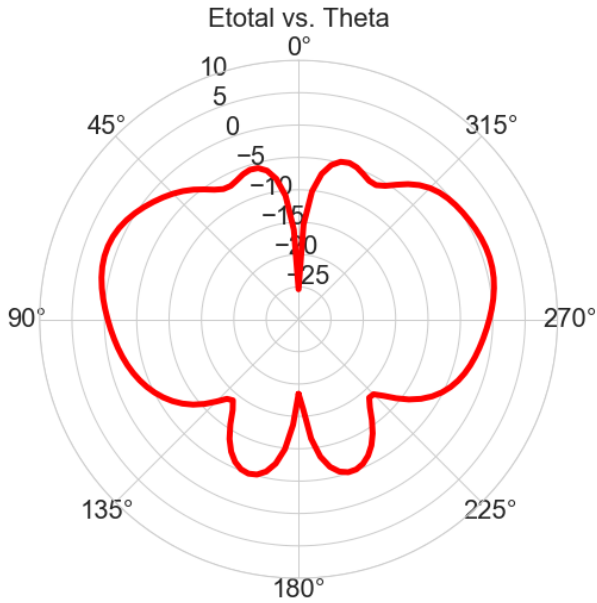

Gain dBi, Elevation Cut $\Phi = 0$, Frequency 1800.00(MHz)

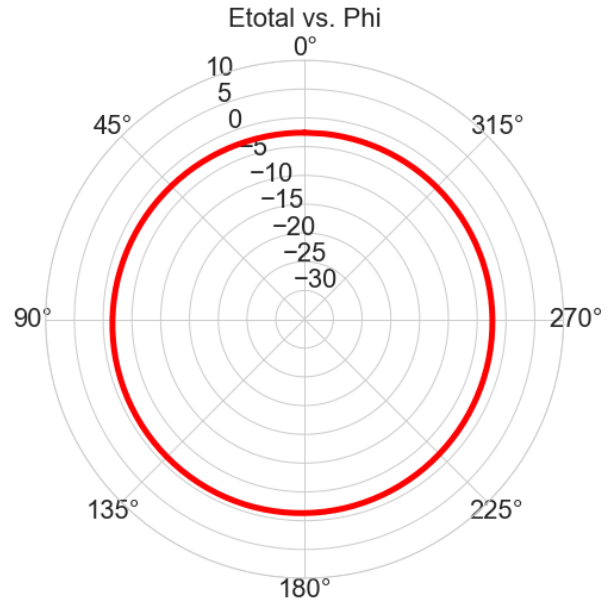

Gain dBi, Conical Cut $\Theta = 45$, Frequency 1800.00(MHz)

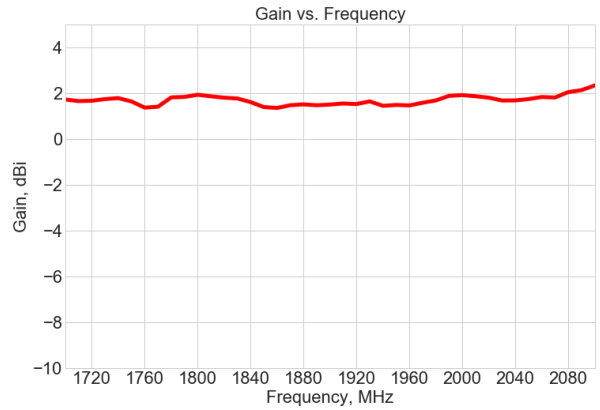
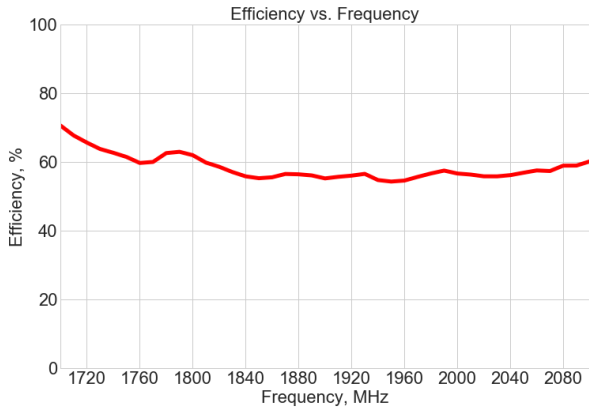

DRAWING REVISION HISTORY			
REV	DESCRIPTION	DATE	BY
A	INITIAL RELEASE	2020-09-24	QZ

D
C
B
A

D
C
B
A

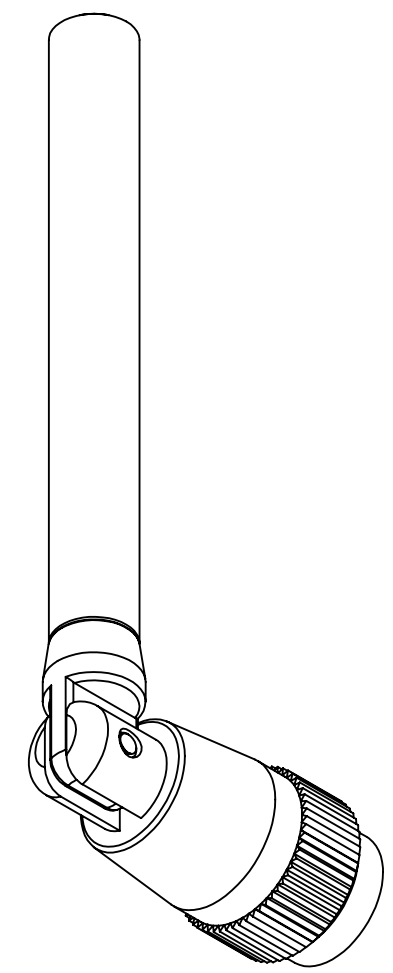
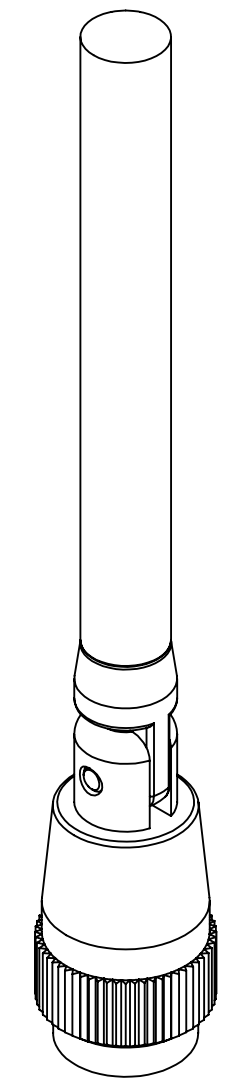
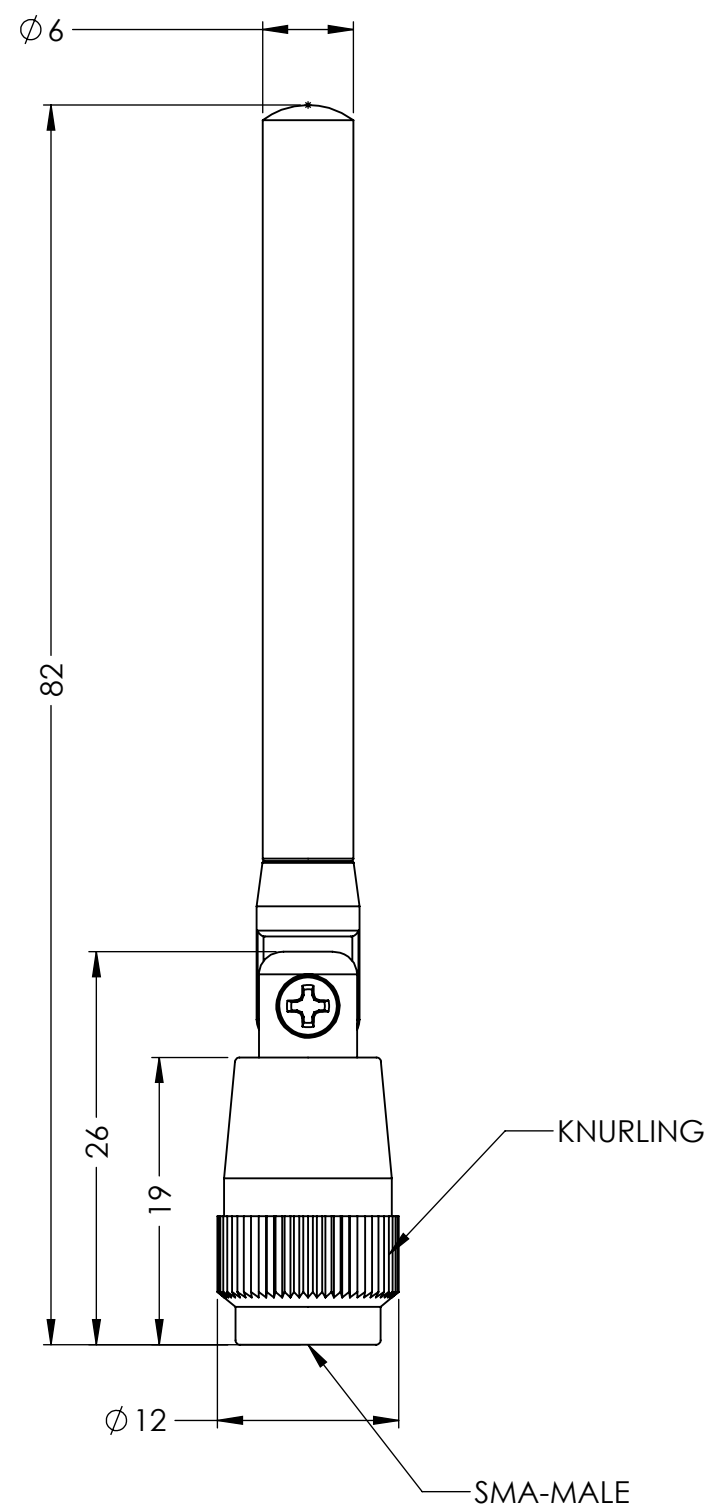

NOTES:
BASE COULD BE ROTATED TO ± 90 DEGREES.

ITEM 100-00140-01 REVISION HISTORY			
REV	DESCRIPTION	DATE	BY
A	INITIAL RELEASE	2020-09-24	QZ

PROPRIETARY AND CONFIDENTIAL

THE INFORMATION CONTAINED IN THIS DRAWING IS THE SOLE PROPERTY OF MAXTENA, INC. ANY REPRODUCTION IN PART OR AS A WHOLE WITHOUT THE WRITTEN PERMISSION OF MAXTENA, INC IS PROHIBITED.

UNLESS OTHERWISE SPECIFIED:	NAME	DATE
DIMENSIONS ARE IN MM	DRAWN	QZ 2020-09-24
TOLERANCES:	CHECKED	ZX 2020-09-24
FRACTIONAL \pm	ENG APPR.	NPC 2020-09-30
ANGULAR: MACH $\pm .5^\circ$ BEND \pm	MFG APPR.	
INTEGER ± 2	Q.A.	
INTERPRET GEOMETRIC TOLERANCING PER:	CAD MAINTAINED. CHANGES SHALL BE INCORPORATED BY THE DESIGN ACTIVITY.	
	DO NOT SCALE DRAWING	

MAXTENA, INC		
TITLE: 100-00140-01 MEA-960-LTE		
SIZE B	DWG. NO. 117-00353-01	REV A
CAGE CODE: 5KQH7	SCALE: NONE	SHEET 1 OF 1

8 7 6 5 4 3 2 1

8 7 6 5 4 3 2 1